

MAXIMA ULTRA

SPECIFIKACIJE I PODRUČJE PRIMJENE

- Maxima Ultra rampe za letve do 8 m, 230 V trofazni asinkronski motor s pretvaračem frekvencije.
- Maxima Ultra 36, sa širinom otvaranja do 6 m i vremenom otvaranja od 0,7 s, pogodan za vrlo intenzivnu upotrebu i česte vožnje unatrag, opcijski gornji poklopac s RGB svjetlima
- Maxima Ultra 36 XL, širine otvora do 6 m i vremena otvaranja od 3,9 s, pogodna za vrlo intenzivnu upotrebu i česte vožnje unatrag, opcijski gornji poklopac s RGB svjetlima, jača opruga u usporedbi s MAXIMA ULTRA 36
- Maxima Ultra 68, širine otvora do 8 m i vremena otvaranja 6,5 s, pogodna za prometne prolaze i česte preokrete (naplatne rampe na autocestama, prometna parkirališta itd.), U-Link protokol

PREDNOSTI ZA KRAJNJE KORISNIKE I PROFESIONALCE

- Profesionalna elektromehanička Rampa s inverterskom tehnologijom i asinkronim trofaznim za teške uvjete rada motor, dizajniran za rad u širokom rasponu uvjeta upotrebe, poput velikih parkirališta ili autoceste naplatne kućice s čestim preokretima kretanja. Sustav protiv vandalizma za zaštitu reduktora pomoću sustava radilice, koji također osigurava glatkoću i sklad kretanja.
- Grane mogu biti opremljene LED svjetlima visoke vidljivosti.
- Kapa s RGB LED svjetlima (opcija) koja pruža treptanje, semafor i dijagnostičke funkcije (Ultra 36 modeli). Opremljen U-Link protokolom, može se integrirati u Parking Management.



ULTRA 36

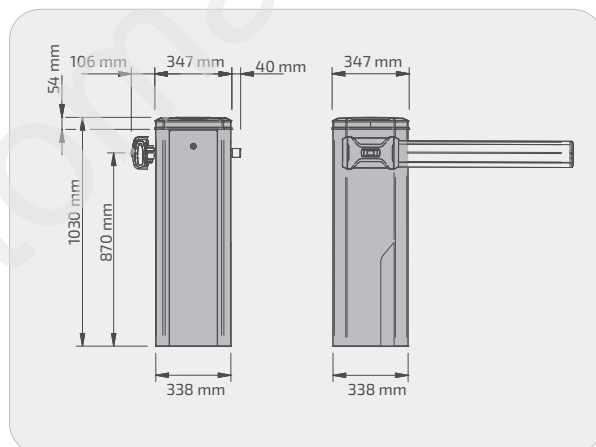

PREPORUČENI PROIZVODI MAXIMA ULTRA 36 / XL

- CROWN Maxima U36 - Gornji poklopac bez svjetala
- CROWN RGB Maxima U36 - Gornji poklopac s RGB svjetlima (bljeskanje, semafor, dijagnostika)
- DIMA PRO36 - Montažna baza za MAXIMA ULTRA 36
- BOOM PS30 - Aluminijska letva, duljina 3 m
- BOOM PS40 - Aluminijska letva, duljina 4 m
- BOOM PS50 - Aluminijska letva, duljina 4 m
- BOOM PS60 - Aluminijska letva, duljina 6 m
- HYPHEN PS - Unutarnja podloga za letvu, preporučuje se za letve od 5 m sa/bez pribora. Mora se naručiti zasebno s Maxima Ultra 36 XL
- OMEGA PS MAXIMA U36 - prihvat za BOOM PS
- OMEGA FRA PS M. U36 - Držač za nosače BOOM PS
- ADJ FOOT - Podesiva potporna noga s oprugom za BOOM PS
- FAF UNI R - Univerzalna podesiva potporna vilica za sve nosače, preporučuje se za ugradnju s rubovima
- EBB KIT ATML - Električna brava za ATML i BOOM PS koja se ugrađuje na FAF UNI R
- BTM SKIRT - Donji rub za BOOM PS letve, duljina modula 2 m
- FULL SKIRT - Puna zastor (gornja i donja) za BOOM PS grane, duljina modula 2 m, zahtijeva BRACKET SKIRT za sidrenje prvog modula na tijelo rampe
- BRACKET SKIRT - Spojni nosač između tijela rampe i BTM SKIRT ili FULL SKIRT
- LIGHT PS 30-B - Intenzivna crveno-zelena svjetla za BOOM PS granu do 3 m
- LIGHT PS 40-B - Intenzivna crveno-zelena svjetla za bum BOOM PS do 4 m
- LIGHT PS 50-B - Intenzivna crveno-zelena svjetla za BOOM PS bum do 5 m
- LIGHT PS 60-B - Intenzivna crveno-zelena svjetla za BOOM PS bum do 6 m
- ALLU 2 MAXIMA ULTRA - Modul napajanja prednjih svjetala za Maxima Ultra



ULTRA 68

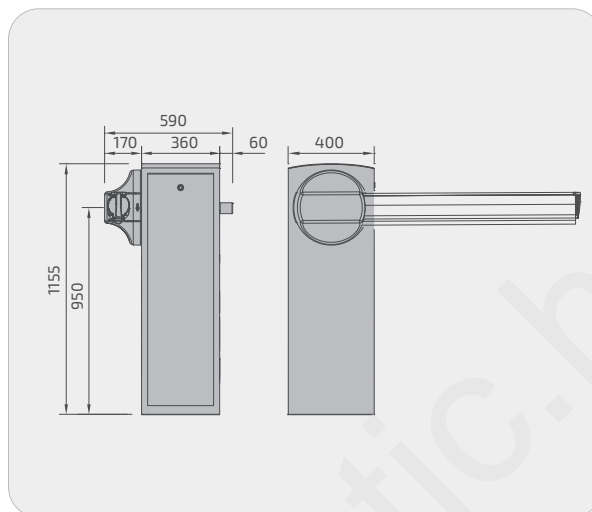

PREPORUČENI PROIZVODI MAXIMA ULTRA 68

- ATM L 60 - aluminijska letva $\varnothing 92$ mm, duljina 6 m
- Bankomat L EXT2 - Produžetak grane ATM L 60, duljina 2 m
- IS ATML - Unutarnja armatura za granu ATM L
- RST ATM - Aluminijska rešetka ovješena ispod grane samo za ATML grane, cijena za 3 m
- OMEGA ATM L U - Držač nosača bankomata za MAXIMA ULTRA 68
- OMEGA FRC ATM L U - Dvostruki nosač za nosač bankomata L 60 za MAXIMA ULTRA 68
- GA ATM - Podesiva potporna noga za bankomate
- FAF UNI R - Univerzalna podesiva potporna noga za sve nosače, preporučuje se za ugradnju s rešetkom
- ATM LIGHT 3 R/G 2 W - Set crveno-zelenih LED svjetala za bankomate do 3 m
- ATM LIGHT 5 R/G 2 W - Set crveno-zelenih LED svjetala za bankomate do 4 m
- ATML LIGHT 8 R/G 2 W - Set crveno-zelenih LED svjetala za ATM L grane do 8 m
- ALLU 2 MAXIMA ULTRA - Modul napajanja za Maxima Ultra
- MCL opruge za MAXIMA ULTRA 68 naručiti zasebno
- PCA ATM 5 - Gumena zaštita (crvena) za bankomate do 5 m
- PCA ATM 8 - Gumena zaštita (crna) za nosače bankomata L do 8 m

OPIS PROIZVODA	REFERENCA SOMFY	REFERENCA BFT
Maxima Ultra 36**	2600943	P940093 00002
Maxima Ultra 36 XL**	2613062	P940094 00002
Maxima Ultra 68	2600872	P940074 00002
CROWN Maxima U36	2601327	P940095 00000
CROWN RGB Maxima U36	2600942	P940095 00003

TEHNIČKI PODACI







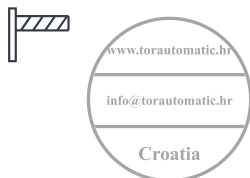









	MAXIMA ULTRA 36	MAXIMA ULTRA 36 XL	MAXIMA ULTRA 68
Kontrolna jedinica	CSB-XT		
Napajanje motora	230 V		
Motor	3-fazni asinkroni		
Reduktora	u uljnoj kupelji		
Širina prolaza*	2 do 6 m	4,75 do 6 m	4 do 8 m
Vrijeme otvaranja i zatvaranja*	0,7 do 3,9 s		5 do 6,5 s
Broj ciklusa dnevno	5,000 (6 m) do 20,000 (3 m)		2 000
Broj ciklusa do kvara	7 000 000		2 000 000
Usporavanje	prilikom otvaranja i zatvaranja		
Reakcija na udar	s preokretom pokreta tijekom zatvaranja (enkoder)		
Blokada	Mehanički		
Deblokiranje	Unutar ormarića		
Radno opterećenje	Kontinuiran		
Uvjeti rada	-40°C do 60°C		

* Prema duljini grane i konfiguraciji grane

















** Rampa se isporučuje bez gornjeg poklopca. Možete birati između poklopca s RGB svjetlosnim 20600942 ili poklopca bez 2601327 svjetla.



DODACI ZA MAXIMA I MAXIMA ULTRA

	OPIS	REFERENCA SOMFY	REFERENCA BFT
	CROWN Maxima U36	2601327	P940095 00000
	CROWN RGB Maxima U36	2600942	P940095 00003
	DIMA PRO36 UL	2616394	P120088
	BOOM PS30	2601376	P120087 00001
	BOOM PS40	2601377	P120087 00002
	BOOM PS50	2601378	P120087 00003
	BOOM PS60	2601277	P120087 00004
	HYPHEN PS	2601388	P120091
	OMEGA PS MAXIMA U36	2601263	P120084 00000
	OMEGA FRA PS M. U36	2601387	P120094 00000
	ADJ FOOT 3 2	2613063	P120093
	EBB Komplet ATML	2605230	P120079
	BTM SKIRT 4	2601279	P120085
	FULL SKIRT 7	2605234	P120086
	BRACKET SKIRT	2601389	P120095
	LIGHT PS 30-B	2605237	P120089 10001















DODACI ZA MAXIMA I MAXIMA ULTRA

	OPIS	REFERENCA SOMFY	REFERENCA BFT
	LIGHT PS 40-B	2605238	P120089 10002
	LIGHT PS/ES 50-IP67	2605243	P120089 20003
	LIGHT PS 60-B	2605240	P120089 10004
	ALLU 2 MAXIMA ULTRA	2601276	P120075
	ATM 30	2613057	P120102 00002
	ATM 40	2613058	P120102 00003
	ATM 50	2613059	P120102 00004
	ATML60	2605209	P120041 00001
	ATM L EXT2	2600827	P120042
	IS ATML	2605229	P120078
	ATM 50 90° RG	2605221	P120066 00001
	RST ATM	2600560	P120049
	OMEGA ATM L U	2612600	P120046 00001
	OMEGA FRC ATM L U	2605213	P120047 00001
	GA ATM	2601320	P120050
	FAF UNI R	2601319	P120080

DODACI ZA MAXIMA I MAXIMA ULTRA

www.torautomatic.hr

DODACI ZA MAXIMA I MAXIMA ULTRA

	OPIS	REFERENCA SOMFY	REFERENCA BFT
	ATM LIGHT 3 R/G 2 W	2601312	P120077 00001
	ATM LIGHT 5 R/G 2 W	2601313	P120077 00002
	ATML LIGHT 8 R/G 2 W	2601314	P120077 00003
	MCL7.5 bijela opruga	2601309	P120059
	MLC9 yžuta opruga	2601310	P120060
	MCL 9.5 ljubičasta opruga	2601311	P120061
	MLC11 crna opruga	2605231	P120081
	PCA ATM 3	2601316	P120053 00001
	PCA ATM 5	2600830	P120053 00002
	PCA ATM 8	2601318	P120053 00003
	RME1	2611230	P111274
	RME2	2611209	P111001 00003
	LOOP DETECTOR PRO	2605171	P111786
	SPIRA 2X1	2600569	D110926 00001